



KLEA

Vanity wash-basin 101 x 46 x 1.5 cm. with overflow

REF: 33070

Klea wash-basin with large dimensions, totally integrated in the furniture unit of this collection, with a very functional and modern design.

Tap fittings not included.

REF 33070

COLOURS/FINISHES

01
White

ARTICLES

Ref	Product/Set	Measurements
33070	Vanity Wash-basin with overflow.	101 x 46 x 1,5 cm

Options

33075 Vanity Wash-basin with overflow. 81 x 46 x 1,5 cm

33080 Vanity Wash-basin with overflow. 61 x 46 x 1,5 cm

PRODUCT INFORMATION

Features

Vanity Wash-basin 101x46x1,5 cm. with overflow. / 17,2 kg. / 24 units pallet. Compatible with Klea furniture.

Useful information

Different sizes and styles with straight or curved lines. Whether you prefer a sensual style or a minimalist option. The choice of the Wash-basin is one of the keys to establish the style you wish to attain. Express your personality through any of these pieces, which will give your bathroom an elegant and modern touch.

Guarantee

Gala products are guaranteed against any manufacturing defects, from the date of purchase of the product, only if the installation has been carried out in accordance with Gala's installation instructions and, applying the current legislation on electrical and sanitary appliances, by authorised staff. The guarantee period for vitreous china is of 5 years.

Installation

Please check our product installation manuals.

Maintenance

Cleaning should preferably be carried out using liquid detergent and a brush or sponge. Do not scrape with metal blades or steel scourer. Every six months it is advisable to check the wastepipe connections and check that there are no leaks.

COMPLEMENTS



SUGGESTIONS

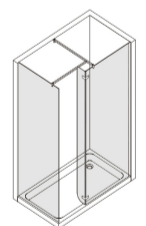
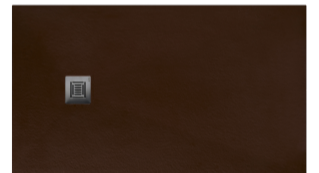

SETTING





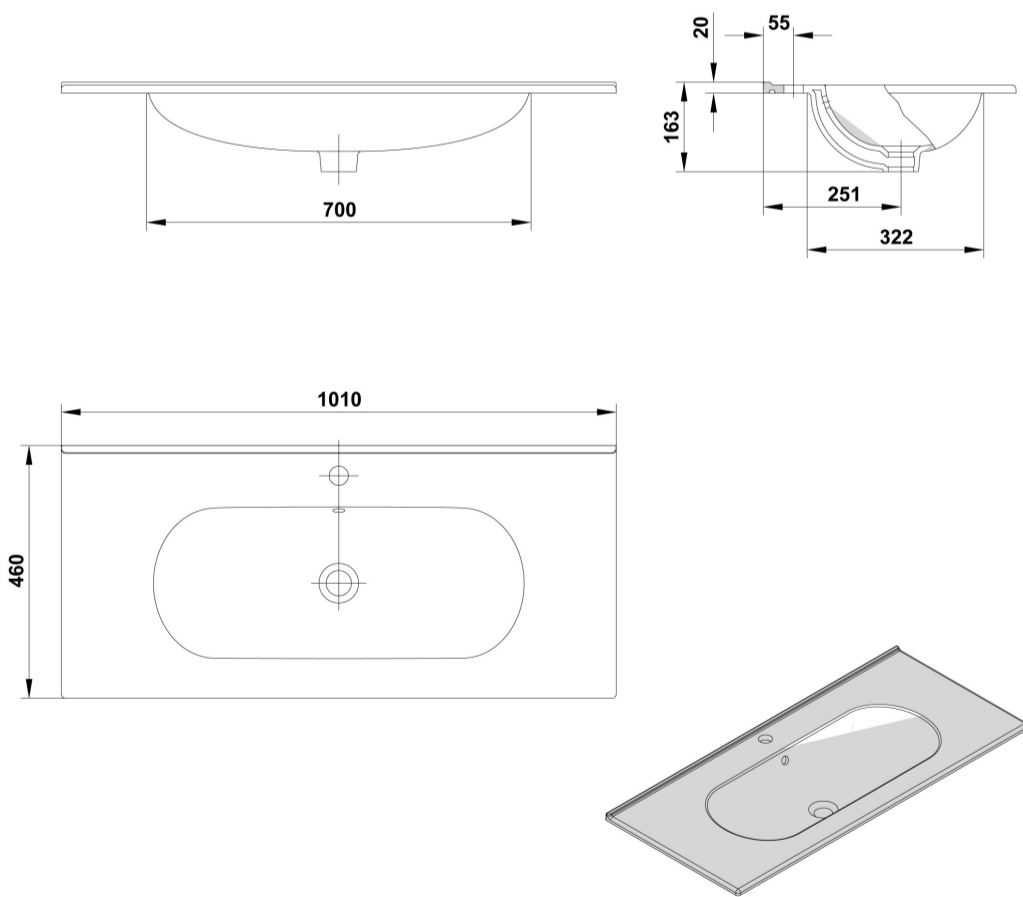





TECHNICAL DRAWINGS



Downloads

2D

-  121.27 KB  Vanity wash-basin 101 x 46 x 1.5 cm. with overflow - Técnico (.AI)
-  157.35 KB  Vanity wash-basin 101 x 46 x 1.5 cm. with overflow - Técnico (.DWG)
-  842.78 KB  Vanity wash-basin 101 x 46 x 1.5 cm. with overflow - Técnico (.DXF)
-  132.19 KB  Vanity wash-basin 101 x 46 x 1.5 cm. with overflow - Técnico (.PDF)

bimobject™

-  ArchiCAD 
-  Revit 