



ELIA

Wall hung WC pan 52,5x35 cm.

REF: 18172

Wall-hung WC with P-trap, the best option for projects with a tight budget. Wall support frame option available.

Set price includes: wall-hung WC pan and polypropylene fixed seat.

REF 18172

COLOURS/FINISHES

01
White

ARTICLES

Ref	Product/Set	Measurements
	Wall-hung WC	
18172	Wall hung WC pan horizontal outlet. Wall support frame option available	52,5 x 35 cm
51370	Fixed seat	
Options		
51370	Fixed seat	
51379	Soft closing seat	
Components/Installation		
55483	WC Full Frame Eon. Installation system for wall mounted toilet on light wall. 6/3 litres, 4,5/3 litres and 4/2 litres flush.	
5056369	Dual push-button Eon3 Chrome gloss	

SUGGESTIONS



PRODUCT INFORMATION

Features

WC pan 52,5 x 35 cm. horizontal outlet. / 16 kg. / 24 units pallet. Wall support frame option available.

Guarantee

Gala products are guaranteed against any manufacturing defects, from the date of purchase of the product, only if the installation has been carried out in accordance with Gala's installation instructions and, applying the current legislation on electrical and sanitary appliances, by authorised staff. The guarantee period for vitreous china is of 5 years.

Installation

Please check our product installation manuals.

Certificates

High quality is a constant at Gala in order to guarantee the technical and aesthetic features as well as the performance of our products. Please check our product quality certificates.

Maintenance

Cleaning should preferably be carried out using liquid detergent and a brush or sponge. Do not scrape with metal blades or steel scourer. Every six months it is advisable to check the wastepipe connections and check that there are no leaks.

SETTING





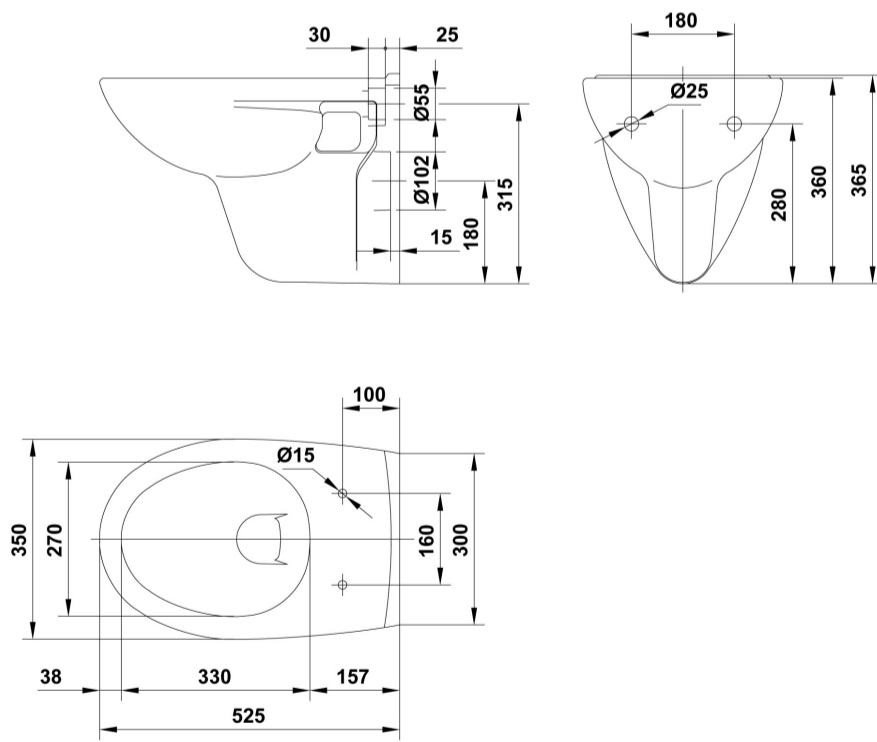

















TECHNICAL DRAWINGS







Downloads

2D

-  85.69 KB  Wall hung WC pan 52,5x35 cm. - Técnico (.AI)
-  63.26 KB  Wall hung WC pan 52,5x35 cm. - Técnico (.DWG)
-  449.36 KB  Wall hung WC pan 52,5x35 cm. - Técnico (.DXF)
-  99.29 KB  Wall hung WC pan 52,5x35 cm. - Técnico (.PDF)
-  28.23 KB  Wall hung WC pan 52,5x35 cm. - Alzado (.DWG)
-  38.17 KB  Wall hung WC pan 52,5x35 cm. - Alzado (.DXF)
-  34.08 KB  Wall hung WC pan 52,5x35 cm. - Lateral (.DWG)
-  50 KB  Wall hung WC pan 52,5x35 cm. - Lateral (.DXF)
-  29.31 KB  Wall hung WC pan 52,5x35 cm. - Planta (.DWG)
-  21.87 KB  Wall hung WC pan 52,5x35 cm. - Planta (.DXF)

3D

-  1.68 MB  Wall hung WC pan 52,5x35 cm. - 3D (.DWG)
-  4.27 MB  Wall hung WC pan 52,5x35 cm. - 3D (.DXF)

bimobject™

-  ArchiCAD 
-  Revit 