



MID

Vanity wash-basin 91x46 cm.

REF: 40090

Mid vanity wash-basin, asymmetrical and with overflow. A versatile design full of personality.

Tap fittings not included.

REF 40090

COLOURS/FINISHES

01
White

ARTICLES

Ref	Product/Set	Measurements	€/u
40090	Vanity wash-basin	91 x 46 cm	

PRODUCT INFORMATION

Features

Vanity wash-basin asymmetric 91x46 cm with overflow. / 15 kg / 12 units pallet.

Useful information

The vanity Wash-basins allow more functionality and a perfect integration in the furniture unit, creating contemporary spaces full of balance and harmony.

Guarantee

Gala products are guaranteed against any manufacturing defects, from the date of purchase of the product, only if the installation has been carried out in accordance with Gala's installation instructions and, applying the current legislation on electrical and sanitary appliances, by authorised staff. The guarantee period for vitreous china is of 5 years.

Installation

Please check our product installation manuals.

Certificates

High quality is a constant at Gala in order to guarantee the technical and aesthetic features as well as the performance of our products. Please check our product quality certificates.

Maintenance

Cleaning should preferably be carried out using liquid detergent and a brush or sponge. Do not scrape with metal blades or steel scourer. Every six months it is advisable to check the wastepipe connections and check that there are no leaks.

COMPLEMENTS



SUGGESTIONS



SETTING





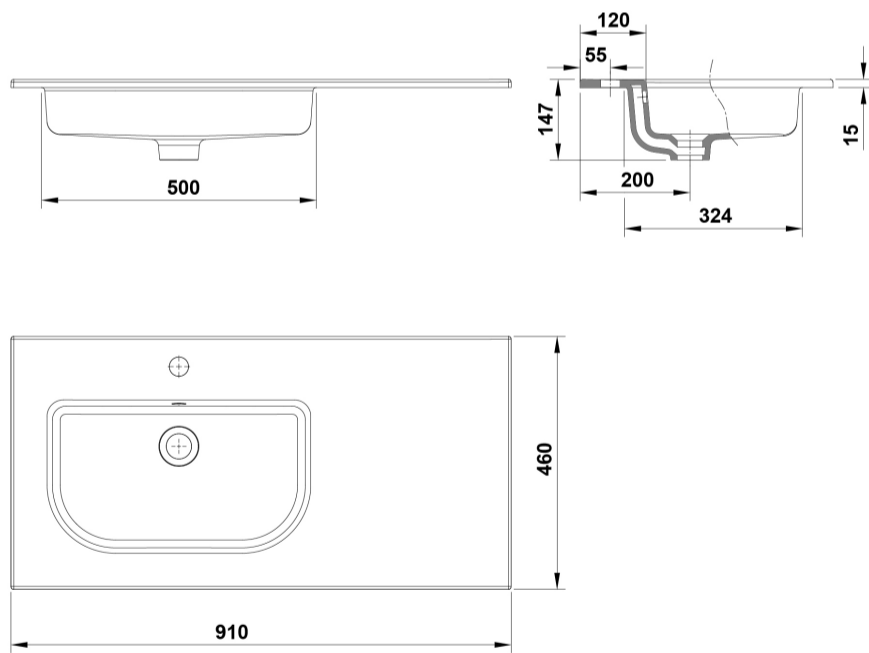





TECHNICAL DRAWINGS



Downloads

2D

-  126.87 KB  Vanity wash-basin 91x46 cm. - Técnico (.AI)
-  98.49 KB  Vanity wash-basin 91x46 cm. - Técnico (.DWG)
-  597.52 KB  Vanity wash-basin 91x46 cm. - Técnico (.DXF)
-  131.64 KB  Vanity wash-basin 91x46 cm. - Técnico (.PDF)