

uBox universal
Base set for finish sets for standard installation
 Finish: n.a. Art. no. : **01001180**



Description

product features

- Consists of: base set, siphon, pre-assembled sealing membrane, height adjustment boards, screed protection cover
- suitable for RainDrain Match, Flex, Rock and Original finish sets
- Application area: new construction, renovation
- water seal: 50 mm
- minimal installation height: 75 mm
- drainage capacity with siphon: up to 42 l/min
- drainage capacity with Dryphon: up to 60 l/min
- connection diameter: DN50
- direction of outlet: horizontal
- connection: 3-sided
- easy fixation to the floor with mounting bracket
- height adjustable with the foam boards
- mounting type: wall-mounted, free in the floor
- easy to clean siphon
- removable siphon
- suitable for soundproof mounting

Article Details

Price excl. VAT

£ 180.00

Technology



Product image



Scale drawing

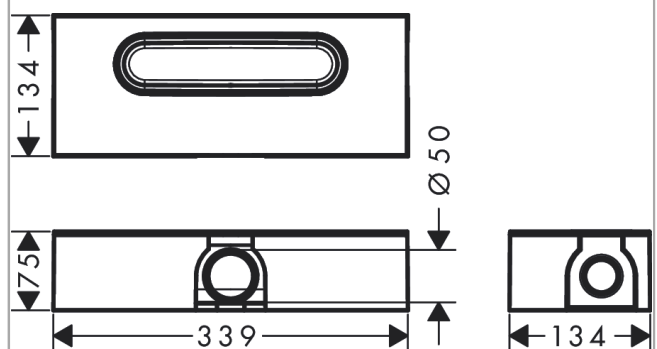

uBox universal
Base set for finish sets for standard installation
 Finish: n.a. Art. no. : 01001180



Exploded Drawing

Year of production: >07/21

1

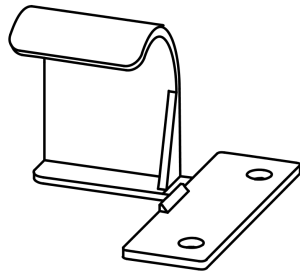

2

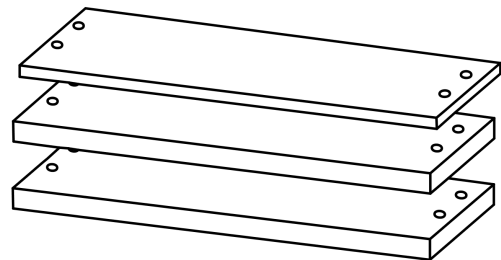

3

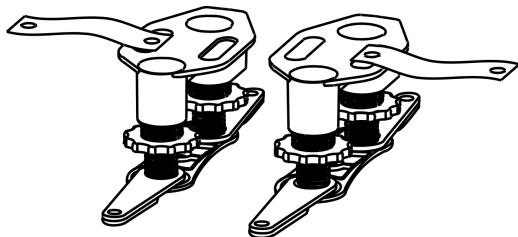

4

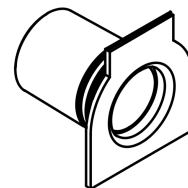

5

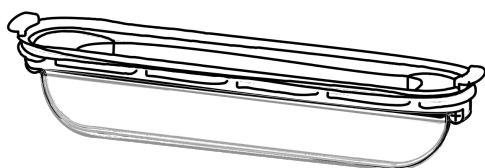

6

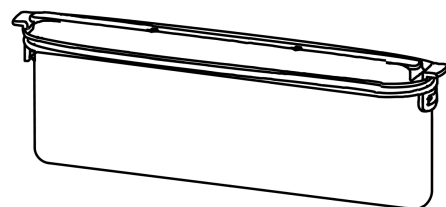

uBox universal
Base set for finish sets for standard installation
 Finish: n.a. Art. no. : **01001180**



Spare part list

Year of production: >07/21

Pos.	Description	Art. no.	Price	PU
1	mounting kit	94384000	-	1
2	compensation set	94325000	-	1
3	mounting-set	94331000	-	1
4	plug	94332000	-	1
5	Dryphon	94326000	-	1
6	trap cpl.	94323000	-	1